

Produkt Katalog

Varmetæpper, Blod- Væskevarmere

Et katalog fyldt med varme patienter

Afsnit 1 Varmetæpper,
Varmemaskiner

Afsnit 2 Pressure Infuser

Afsnit 3 Blod-, Væskevarmere

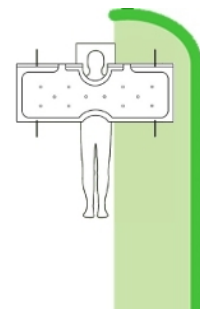
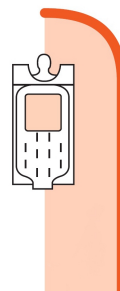
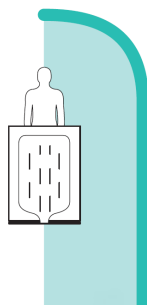
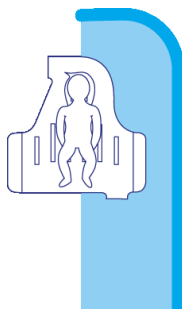

Den dokumenterede effekt ved brugen af "forced air warming" tæpper er velkendt. Det vigtigste er at "forced air warming" forebygger varmetab, holder normal kerntemperatur hos patienten under anæstesi, reducerer tiden på opvågnings- og intensivafdeling, og blandt mange øvrige fordele bl.a. reducerer den efterfølgende infektionsrisiko.

Det er ligeledes dokumenteret at brugen af varme væsker kan vedligeholde temperaturen i patienten, at det ikke er muligt at opvarme patienten ved brug af varme væsker, men at patienten afkøles hvis væsken ikke er opvarmet.

Det er derfor altid vigtigt at holde patienten varm med et aktivt varmesystem, og vigtigt at intravenøse væsker bliver varmet op inden infusion.



For øvrige produkter se TGM web: www.tgm-teknik.dk
eller få tilsendt katalog med bl.a. SpO₂ Prober, Temperatur Prober, O₂ Sensorer, Pulsoximeter

Varmeenhed

| | |
|---|--|
|  | <p>TGm varenr.: 5-05-400</p> <p>Model CSW 4000</p> <p>Temperatur indstillinger +/- 2°C:</p> <ul style="list-style-type: none"> • Rum temperatur • 34°C • 37°C • 40°C • 43°C • 46°C - Boost <p>Slangeovertræk kan maskinvaskes</p> <p>Meget støjsvag</p> <p>Filter: Hepa 0,2 micron, skiftes: 1.000 timer</p> <p>Vægt: 6 kg Str.: 29 x 22 x 40 cm Varmelegme: 1.000 W</p> |
|  <p>Stativ Model A Stativ Model B</p> | <p>Stativ til varmemaskine</p> <p>TGm varenr.: 5-05-410 Model A: Højde 67 cm 5 hjul Vægt 2,25 kg</p> <p>TGm varenr.: 5-05-411 Model B: Højde 80 cm 4 hjul Vægt 3,0 kg</p> |

Varmetæpper

- Farve: Fersken
- Farvestof: **ØKOLOGISK** naturfarve
- Materiale: LDPE
1. klasses nonwoven
Åndbart
Latex og PVC fri
Meget blødt og patient venligt

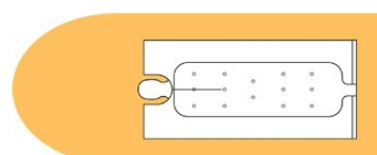
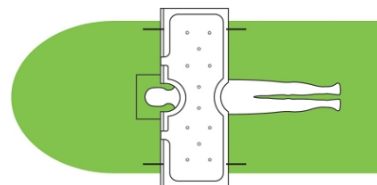

Standard tæpper

| | |
|--|---|
| <p>TGm varenr.: 2-05-104</p> <p>Upper Body Blanket Model CLM0104</p> <p>Str.: 57 x 196 cm</p> <p>Antal pr ks: 30</p> | <p>TGm varenr.: 2-05-102</p> <p>Lower Body Blanket Model CLM0102</p> <p>Str.: 100 x 120 cm</p> <p>Antal pr ks: 30</p> |
|--|---|

| | |
|--|--|
| <p>TGm varenr.: 2-05-101</p> <p>Full Body Blanket Model CLM0101</p> <p>Str.: 100 x 195 cm</p> <p>Antal pr ks: 30</p> | <p>TGm varenr.: 2-05-103</p> <p>Torso Blanket Model CLM0103</p> <p>Str.: 100 x 124 cm</p> <p>Antal pr ks: 30</p> |
|--|--|

Pediatric tæpper - Neonatal tæpper

| | |
|---|--|
| <p>TGm varenr.: 2-05-105</p> <p>Pediatric Neonatal Blanket Model CLM0105</p> <p>Str.: 87 x 89 cm</p> <p>Antal pr ks: 10</p> |  |
|---|--|

Pediatric tæpper - Neonatal tæpper

| | |
|--|---|
| <p>TGm varenr.: 2-05-106</p> <p>Pediatric Tube Blanket Model CLM0106</p> <p>Str.: 78 x 117 cm</p> <p>Antal pr ks: 10</p> | <p>TGm varenr.: 2-05-107</p> <p>Pediatric Child Blanket Model CLM0107</p> <p>Str.: 130 x 92 cm</p> <p>Antal pr ks: 10</p> |
|--|---|

Special tæpper

| | |
|---|---|
| <p>TGm varenr.: 2-05-108</p> <p>Cardiac Access Blanket Model CLM0108</p> <p>Str.: 100 x 195 cm</p> <p>Antal pr ks: 30</p> | <p>TGm varenr.: 2-05-118</p> <p>Abdominal Access Blanket Model CLM0118</p> <p>Str.: 180 x 190 cm</p> <p>Antal pr ks: 30</p> |
|---|---|

| | |
|---|--|
| <p>TGm varenr.: 2-05-121</p> <p>Multi Access Blanket Model CLM0121</p> <p>Str.: 100 x 195 cm</p> <p>Antal pr ks: 30</p> | <p>TGm varenr.: 2-05-124</p> <p>Surgical Access Blanket Model CLM0124</p> <p>Str.: 100 x 195 cm</p> <p>Antal pr ks: 30</p> |
|---|--|

Special tæpper

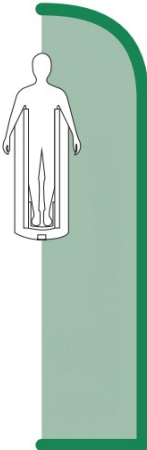
| | |
|---|--|
| <p>TGm varenr.: 2-05-122</p> <p>Adult Tube Blanket Model CLM0122</p> <p>Str.: 100 x 217 cm</p> <p>Antal pr ks: 30</p>  | <p>TGm varenr.: 2-05-113</p> <p>Cath Lab Blanket Model CLM0113</p> <p>Str.: 20 x 210 cm</p> <p>Antal pr ks: 30</p>  |
|---|--|

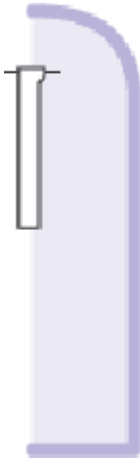
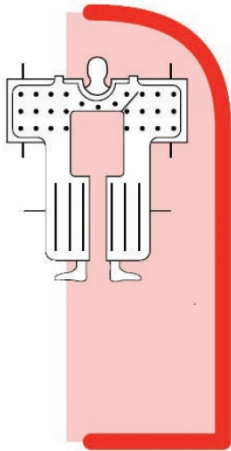
| | |
|---|---|
| <p>TGm varenr.: 2-05-112</p> <p>Multi Purpose Air Sock Blanket Model CLM0112</p> <p>Str.: 100 x 12 cm</p> <p>Antal pr ks: 10</p>  | <p>TGm varenr.: 2-05-125</p> <p>Lithotomy & Laparoscopy Blanket Model CLM01</p> <p>Str.: 180 x 190 cm</p> <p>Antal pr ks: 30</p>  |
|---|---|

| | |
|---|--|
| <p>NYT TÆPPE</p> <p>UNDERBODY BLANKET</p> <p>TGm varenr.: 2-05-130</p> <p>Adult Under Body Blanket Model CLM0130</p> <p>Str. 100 x 220 cm</p> <p>Antal pr ks: 30</p> <p><i>pt ingen billede</i></p> |  |
|---|--|

Pressure Infuser



Model AutoPC **Enkelt** - TGM varenr.: 5-11-550

Model AutoPC **Dobbelt** - TGM varenr.: 5-11-510

Tryk: 100 mm Hg til 300 mm Hg.
Indstilles i interval på 5 mm Hg



Alarm ved 20 mm Hg over- undertryk i.f.t. indstilling

Vægt: 2 kg enkelt
4 kg dobbelt

250 ml til 1.000 ml standard poser

Power: 12 V udtag fra AutoMer Blod- Væskevarmer
eller alm. 220 V

Varmeenhed
Standard Flow, High Flow

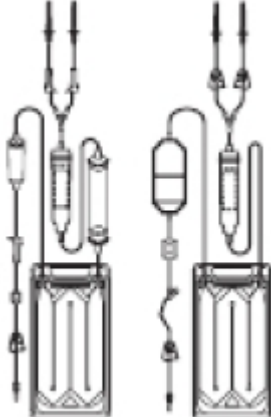
| | |
|---|--|
|  | <p>TGm varenr.: 5-11-500</p> <p>Model AutoMer</p> <p>Temperatur indstilling: 40°C Alarm: 43°C</p> <p>Flow: KVO - 40.000 ml/t (KVO - 750 ml/min)</p> <p>Placering: Horisontal eller vertikal</p> <p>Vægt: 3,0 kg</p> <p>Str.: 187 x 62 x 292 mm</p> <p>Varmelegme: 900W</p> |
|  | <p>Standard Flow til AutoMer</p> <p>TGm varenr.: 2-11-100</p> <p>Standard Flow Set</p> <p>Flow: KVO - 12.000 ml/t (KVO-200 ml/min)</p> <p>Latex fri</p> <p>Antal pr ks 10 stk</p> |
|  | <p>High Flow til AutoMer</p> <p>TGm varenr.: 2-11-200</p> <p>High Flow Set</p> <p>Flow: KVO - 45.000 ml/t (KVO-750 ml/min)</p> <p>150 µm blodfilter 0,2 µm luftfilter - fjerner 4 l/min</p> <p>Latex fri</p> <p>Antal pr ks 5 stk</p> |

Varmeenhed - Low Flow

| | |
|--|--|
|  | <p>TGm varenr.: 5-15-150</p> <p>Model GenFlow FIW 4150</p> <p>Flow: 2 - 12 ml/min</p> <p>Udgangs temperatur op til 38°C</p> <p>Str.: 190 x 65 x 45 mm</p> <p>Standard infusions slange indsættes i GenFlow</p> |
|--|--|

Kontakt os for yderligere information

TGm Teknik A/S
Sankt Knuds Vej 37
1903 Frederiksberg C

tgm@tgm-teknik.dk
www.tgm-teknik.dk

Tlf.: 43 96 95 95
Fax: 43 96 98 98